

# Submersible

Pumps • Motors

50Hz **4"**  
**Submersible Pump**

Pumping Solution

# Product data

# 4"

## Stainless steel submersible bore well pumps

### Construction

- Submersible motor & pumps for deep wells of 4" (DN 100 mm).
- Sized for connection to the motor according to NEMA standards.
- Delivery casing with built-in non-return valve.
- All standard pumps are completely manufactured out of stainless steel AISI 304 sheet metal.
- Impellers:**
  - Radial flow impellers**  
W1A, W2A, W3A, W5A
  - Mixed flow impellers**  
W8A, W14A
- Connection: Screwed pipe connection with BSP thread as standard.

### Applications

- Water supply
- Irrigation
- Civil
- Industrial
- Fire fighting

### Performance range

- Flow range: Max. 18.8 m<sup>3</sup>/h
- Head range: Max. 547 metres

### Operating conditions

- Liquid temperature: 0°C to +45°C
- Max. sand content into the water: 50 g/m<sup>3</sup>
- Max. starts per hour: 30 at regular intervals
- Direction of rotation: Clockwise as seen from the pump coupling side

### Special construction on request

- Also available in stainless steel AISI 316 material (for sea water application).
- Also available with NPT thread pipe connection.



# Construction

Stainless steel submersible bore well pumps

# 4"

## Sectional drawing

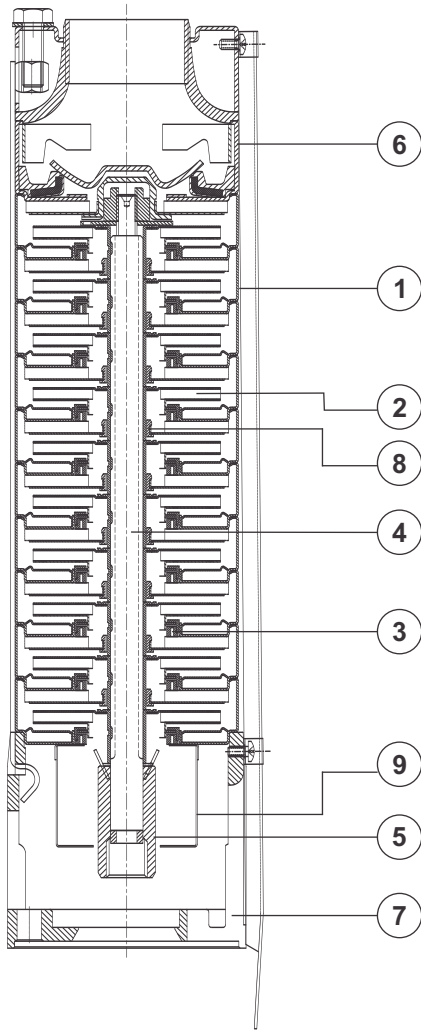

“W” type pump  
W1A, W2A, W3A, W5A

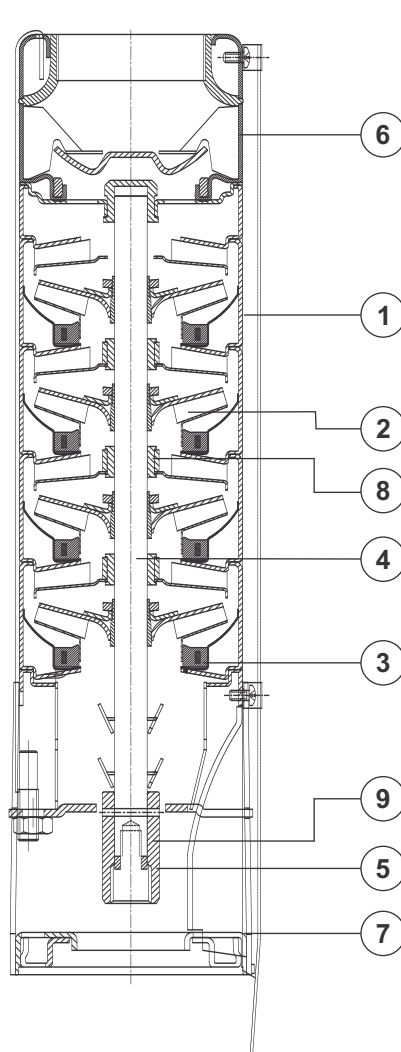

“W” type pump  
W8A

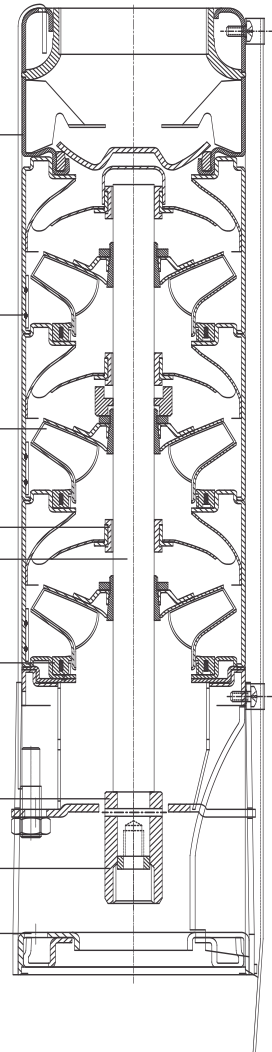

“W” type pump  
W14A

## Materials

Pos.	Component	Material
1	Bowl / Diffuser	Stainless steel AISI 304
2	Impeller	Stainless steel AISI 304
3	Neck ring	NBR
4	Shaft	Stainless steel AISI 316
5	Couple	Stainless steel AISI 316
6	Delivery casing	Stainless steel AISI 304
7	Suction case	Stainless steel AISI 304
8	Bearing bush	NBR
9	Strainer	Stainless steel AISI 304

# Technical data

## Radial flow 4" stainless steel submersible bore well pumps

# W1A

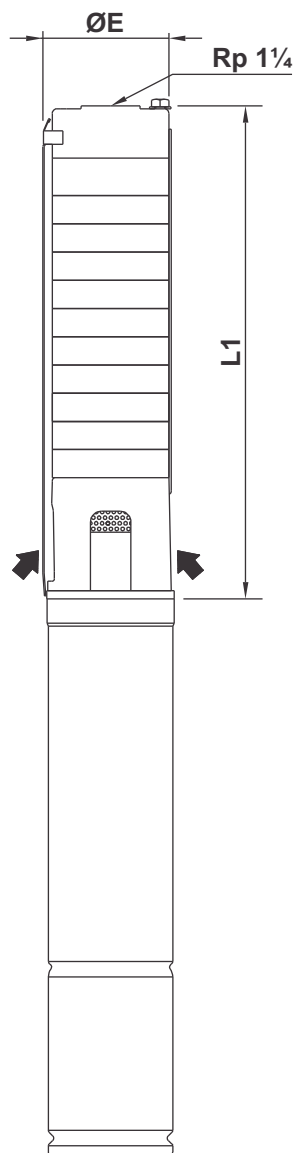

### Performance chart

Pump type	Motor type		kW	HP	Q m <sup>3</sup> /h l/min	n = 2900 rpm					
	Oil filled	Water filled				0	0.2	0.6	0.9	1.2	1.5
						0	3.3	10	15	20	24.7
W1A/9	H4505	L4505	0.37	0.50	H mts.	53	53	47	39	28	14
W1A/14	H4505	L4505	0.37	0.50		81	79	70	58	40	20
W1A/18	H4507	L4507	0.55	0.75		106	103	92	76	54	26
W1A/21	H4507	L4507	0.55	0.75		122	119	105	87	61	30
W1A/28	H4510	L4510	0.75	1.00		163	160	142	118	83	40
W1A/36	H4515	L4515	1.10	1.50		199	196	170	137	93	48
W1A/42	H4515	L4515	1.10	1.50		231	226	197	158	107	54
W1A/50	H4520	L4520	1.50	2.00		277	271	236	188	130	67
W1A/57	H4520	L4520	1.50	2.00		313	306	266	213	145	73

### Dimensions & weights of only Pump

Pump Type	Motor Joining Size	ØE [mm]	L1 [mm]	Pump Gross weight [kg]	Pump Gross volume [m <sup>3</sup> ]
W1A/9	4"	101	344	4.2	0.0051
W1A/14	4"	101	449	5.6	0.0106
W1A/18	4"	101	533	6.5	0.0106
W1A/21	4"	101	596	7.2	0.0106
W1A/28	4"	101	743	8.8	0.0106
W1A/36	4"	101	956	10.6	0.0106
W1A/42	4"	101	1082	12.2	0.0162
W1A/50	4"	101	1250	14.0	0.0162
W1A/57	4"	101	1397	15.7	0.0162

Note: ØE = For single cable motor maximum diameter of pump inclusive of cable guard.  
All dimensions in mm unless otherwise noted.

# Performance curves

Radial flow 4" stainless steel submersible bore well pumps

**W1A**

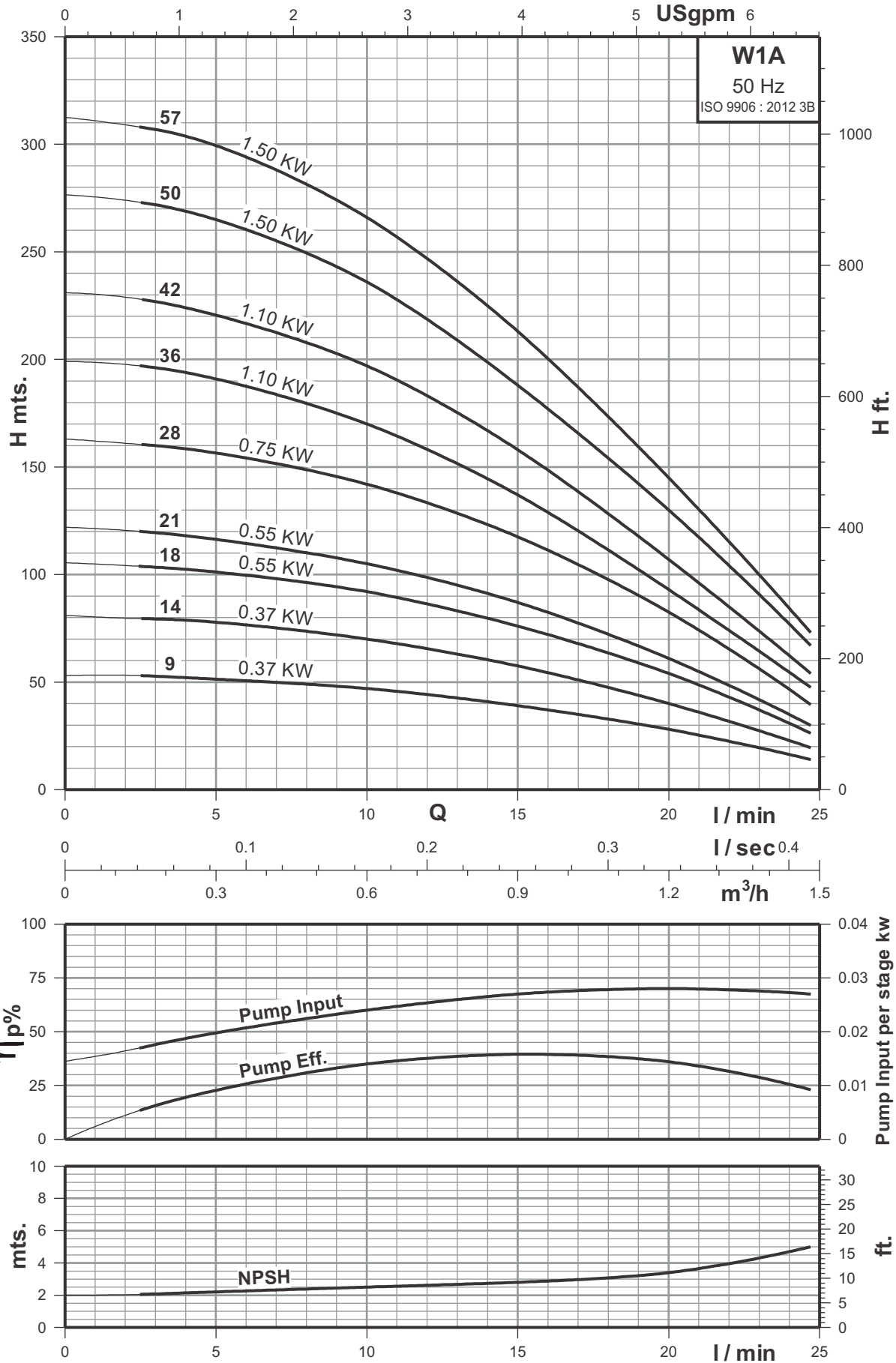

# Technical data

## Radial flow 4" stainless steel submersible bore well pumps

# W2A

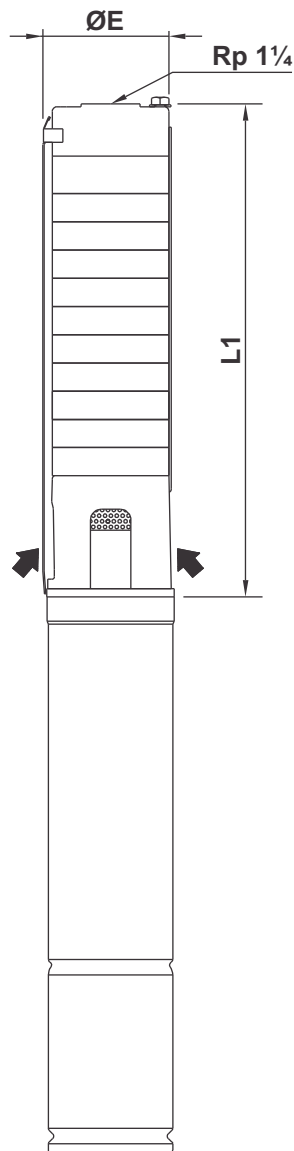

### Performance chart

Pump type	Motor type		kW	HP	Q m <sup>3</sup> /h l/min	n = 2900 rpm					
	Oil filled	Water filled				0	0.4	1.2	1.6	1.9	2.7
						0	6.7	20	27	33	45
W2A/6	H4505	L4505	0.37	0.50	H mts.	36	35	32	29	24	10
W2A/9	H4505	L4505	0.37	0.50		54	52	47	41	34	14
W2A/13	H4507	L4507	0.55	0.75		78	76	67	59	50	21
W2A/18	H4510	L4510	0.75	1.00		108	105	93	83	69	29
W2A/23	H4515	L4515	1.10	1.50		138	135	120	107	90	39
W2A/28	H4520	L4520	1.50	2.00		168	165	147	132	110	48
W2A/33	H4520	L4520	1.50	2.00		196	192	171	154	128	54
W2A/40	H4530	L4530	2.20	3.00		245	239	213	190	158	62
W2A/48	H4530	L4530	2.20	3.00		292	284	252	225	185	70
W2A/55	H4540	L4540	3.00	4.00		336	327	290	260	214	85
W2A/65	H4540	L4540	3.00	4.00		394	385	340	302	249	94
W2A/75	H4555	L4555	4.00	5.50		458	447	397	355	293	118
W2A/90	H4555	L4555	4.00	5.50		547	532	469	419	344	129

### Dimensions & weights of only Pump

Pump Type	Motor Joining Size	ØE [mm]	L1 [mm]	Pump Gross weight [kg]	Pump Gross volume [m <sup>3</sup> ]
W2A/6	4"	101	281	3.5	0.0051
W2A/9	4"	101	344	4.2	0.0051
W2A/13	4"	101	428	5.3	0.0106
W2A/18	4"	101	533	6.5	0.0106
W2A/23	4"	101	638	7.6	0.0106
W2A/28	4"	101	743	8.8	0.0106
W2A/33	4"	101	844	9.9	0.0106
W2A/40	4"	101	1040	11.7	0.0162
W2A/48	4"	101	1208	13.6	0.0162
W2A/55	4"	101	1355	15.2	0.0162
W2A/65	4"	101	1565	18.0	0.0204
W2A/75	4"	101	1954	20.3	0.0204
W2A/90	4"	108	2269	68.0	0.0630

**Note:** ØE = For single cable motor maximum diameter of pump inclusive of cable guard.  
All dimensions in mm unless otherwise noted.

W2A/90 is mounted in sleeve for Rp 2 connection.

# Performance curves

Radial flow 4" stainless steel submersible bore well pumps

**W2A**

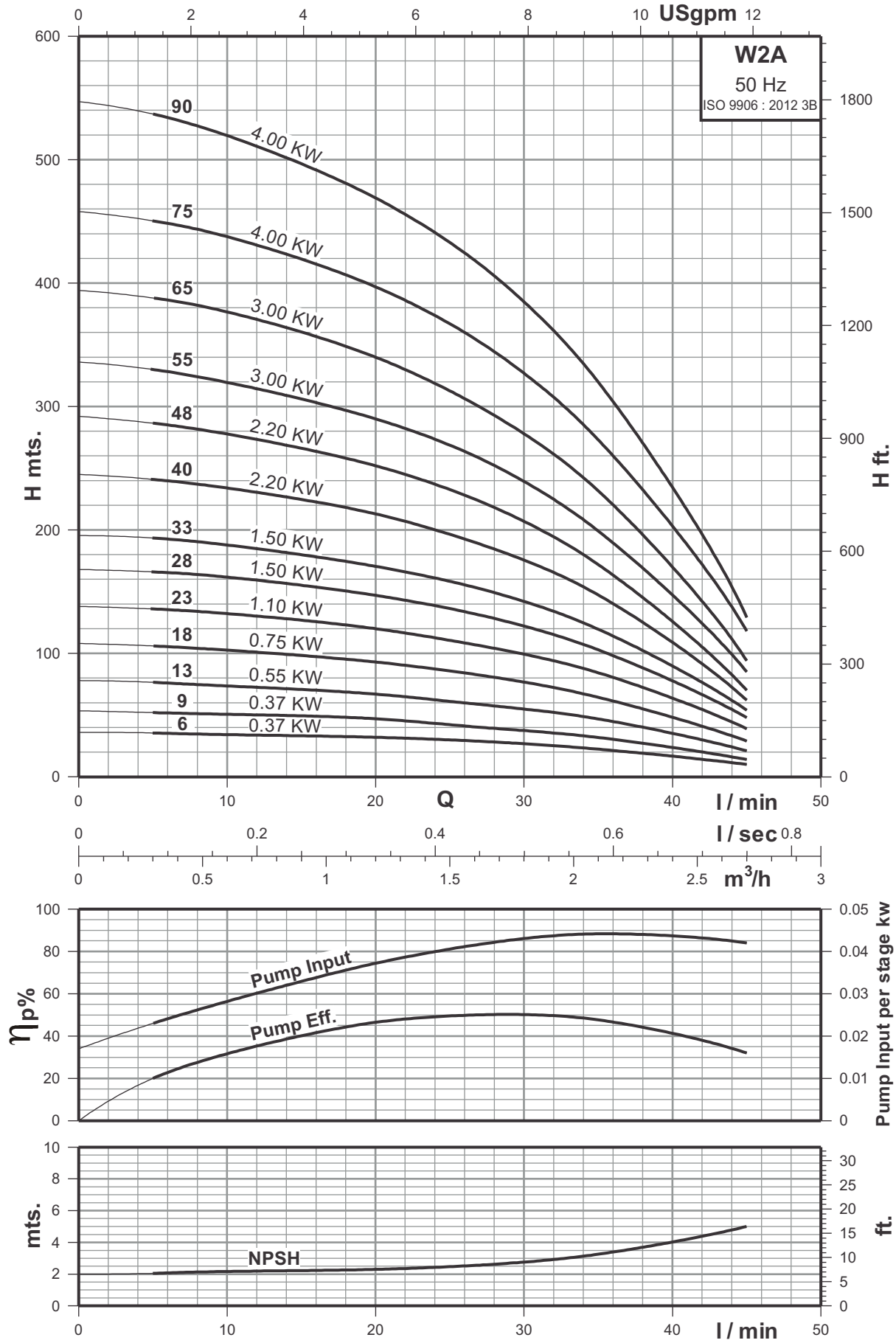

# Technical data

## Radial flow 4" stainless steel submersible bore well pumps

# W3A

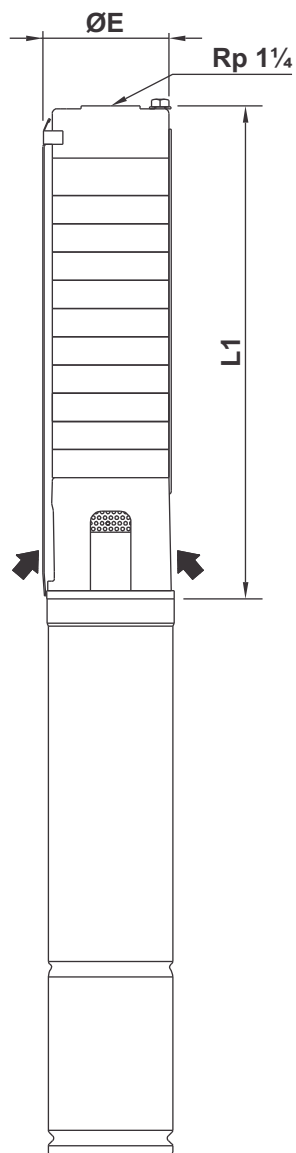

### Performance chart

Pump type	Motor type		kW	HP	Q m <sup>3</sup> /h l/min	n = 2900 rpm					
	Oil filled	Water filled				0	0.8	1.6	2.4	3.1	4.3
						0	13	27	40	53	73
W3A/6	H4505	L4505	0.37	0.50	H mts.	38	36	33	30	24	10
W3A/9	H4507	L4507	0.55	0.75		57	54	50	44	36	15
W3A/12	H4510	L4510	0.75	1.00		76	72	67	60	49	20
W3A/15	H4515	L4515	1.10	1.50		95	90	84	76	62	26
W3A/18	H4515	L4515	1.10	1.50		113	107	100	90	73	30
W3A/22	H4520	L4520	1.50	2.00		139	131	122	110	89	38
W3A/25	H4520	L4520	1.50	2.00		157	149	138	124	100	41
W3A/29	H4530	L4530	2.20	3.00		184	174	163	147	120	52
W3A/33	H4530	L4530	2.20	3.00		209	197	184	166	135	57
W3A/39	H4540	L4540	3.00	4.00		246	233	220	201	170	90
W3A/45	H4540	L4540	3.00	4.00		282	267	252	230	193	100
W3A/52	H4555	L4555	4.00	5.50		328	310	294	269	227	120
W3A/60	H4555	L4555	4.00	5.50		378	357	336	306	258	134
W3A/75	H4575	L4575	5.50	7.50		434	408	378	343	291	162

### Dimensions & weights of only Pump

Pump Type	Motor Joining Size	$\varnothing E$ [mm]	L1 [mm]	Pump Gross weight [kg]	Pump Gross volume [m <sup>3</sup> ]
W3A/6	4"	101	281	3.5	0.0051
W3A/9	4"	101	344	4.2	0.0051
W3A/12	4"	101	407	4.9	0.0051
W3A/15	4"	101	470	5.8	0.0106
W3A/18	4"	101	533	6.5	0.0106
W3A/22	4"	101	617	7.4	0.0106
W3A/25	4"	101	680	8.1	0.0106
W3A/29	4"	101	764	9.0	0.0106
W3A/33	4"	101	848	9.9	0.0106
W3A/39	4"	101	1019	11.5	0.0162
W3A/45	4"	101	1145	12.9	0.0162
W3A/52	4"	101	1292	14.5	0.0162
W3A/60	4"	101	1460	16.3	0.0162
W3A/75	4"	101	1783	20.3	0.0204

**Note:**  $\varnothing E$  = For single cable motor maximum diameter of pump inclusive of cable guard.  
All dimensions in mm unless otherwise noted.



# Performance curves

Radial flow 4" stainless steel submersible bore well pumps

**W3A**

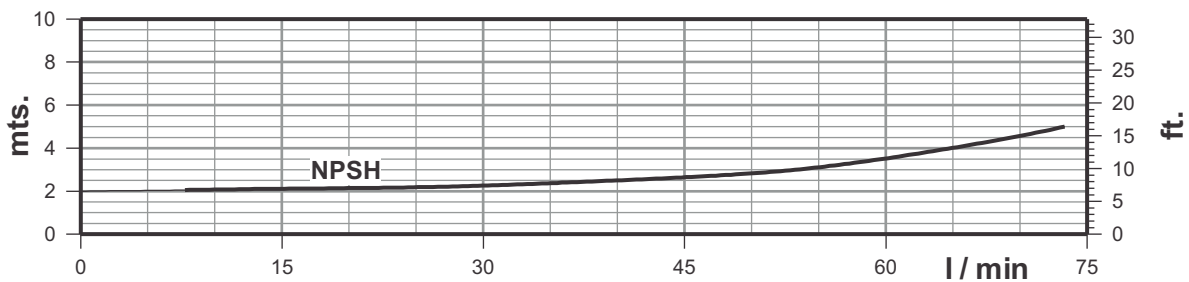
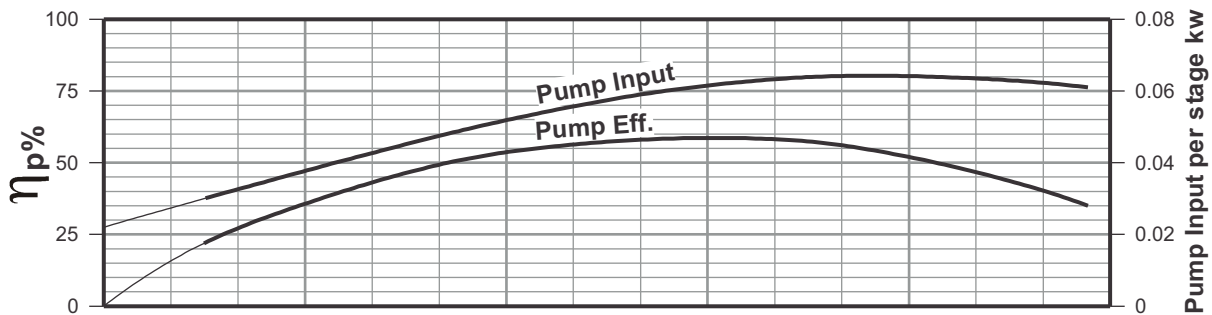
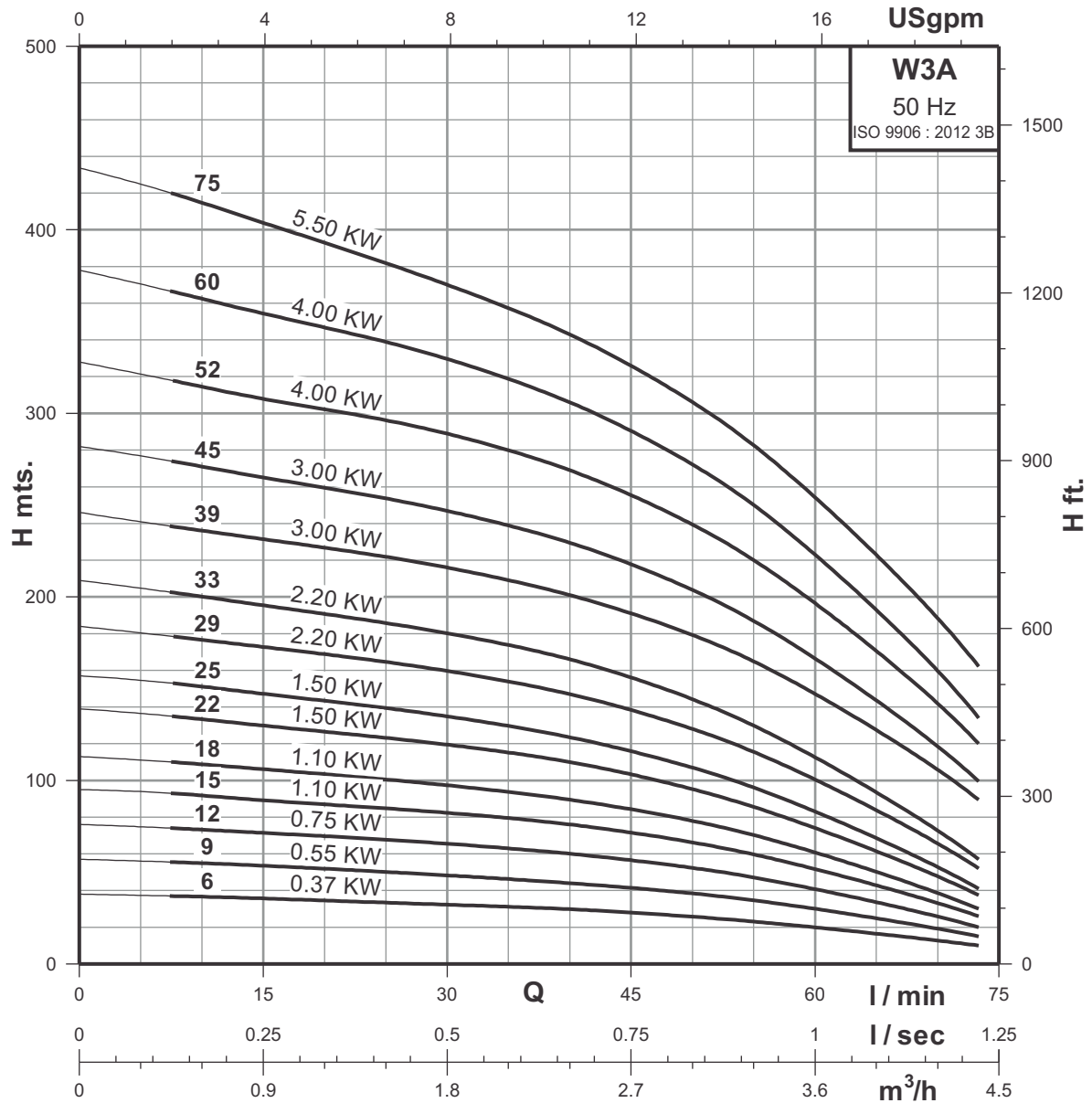

# Technical data

## Radial flow 4" stainless steel submersible bore well pumps

# W5A

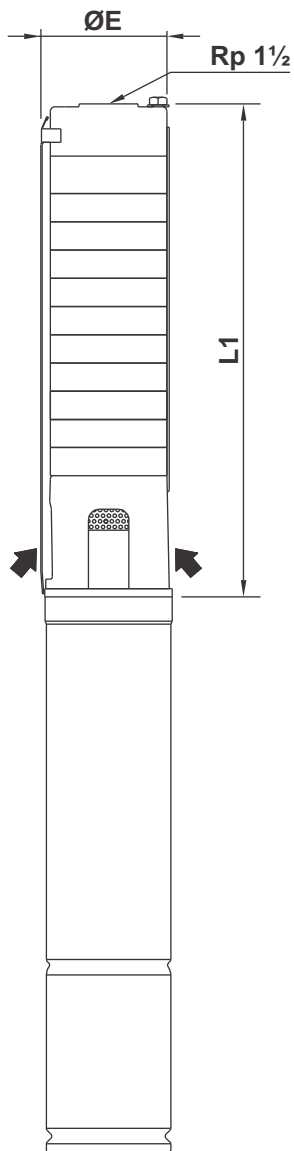

### Performance chart

Pump type	Motor type		kW	HP	Q m <sup>3</sup> /h l/min	n = 2900 rpm					
	Oil filled	Water filled				0	0.7	2.4	4	5.5	6.7
						0	13	40	67	93	113
W5A/4	H4505	L4505	0.37	0.50	H mts.	26	24	23	20	14	-
W5A/6	H4507	L4507	0.55	0.75		39	36	32	29	20	11
W5A/8	H4510	L4510	0.75	1.00		51	48	44	38	27	15
W5A/12	H4515	L4515	1.10	1.50		77	72	65	57	40	22
W5A/17	H4520	L4520	1.50	2.00		109	103	92	80	57	30
W5A/21	H4530	L4530	2.20	3.00		135	127	116	100	73	40
W5A/25	H4530	L4530	2.20	3.00		160	150	137	118	84	45
W5A/33	H4540	L4540	3.00	4.00		211	198	179	154	110	59
W5A/38	H4555	L4555	4.00	5.50		250	236	213	186	134	72
W5A/44	H4555	L4555	4.00	5.50		281	265	239	207	148	80
W5A/52	H4575	L4575	5.50	7.50		333	315	285	249	179	100
W5A/60	H4575	L4575	5.50	7.50		384	365	326	283	202	110
W5A/75	H45100	L6510-KP	7.50	10.0		480	453	409	355	254	137
W5A/85	H45100	L6510-KP	7.50	10.0		542	510	459	397	280	150

### Dimensions & weights of only Pump

Pump Type	Motor Joining Size	ØE [mm]	L1 [mm]	Pump Gross weight [kg]	Pump Gross volume [m <sup>3</sup> ]
W5A/4	4"	101	240	3.1	0.0051
W5A/6	4"	101	282	3.5	0.0051
W5A/8	4"	101	324	4.0	0.0051
W5A/12	4"	101	408	4.9	0.0051
W5A/17	4"	101	513	6.3	0.0106
W5A/21	4"	101	597	7.2	0.0106
W5A/25	4"	101	681	8.1	0.0106
W5A/33	4"	101	849	9.9	0.0106
W5A/38	4"	101	998	11.3	0.0162
W5A/44	4"	101	1124	12.7	0.0162
W5A/52	4"	101	1292	14.5	0.0162
W5A/60	4"	101	1460	16.3	0.0162
W5A/75	4"	101	2146	20.3	0.0204
W5A/75	6"	142	2146	24.0	0.0450
W5A/85	4"	108	2293	62.5	0.0619
W5A/85	6"	142	2356	63.5	0.0619

**Note:** ØE = For single cable motor maximum diameter of pump inclusive of cable guard.  
All dimensions in mm unless otherwise noted.

W5A/85 is mounted in sleeve for Rp 2 connection.

# Performance curves

Radial flow 4" stainless steel submersible bore well pumps

**W5A**

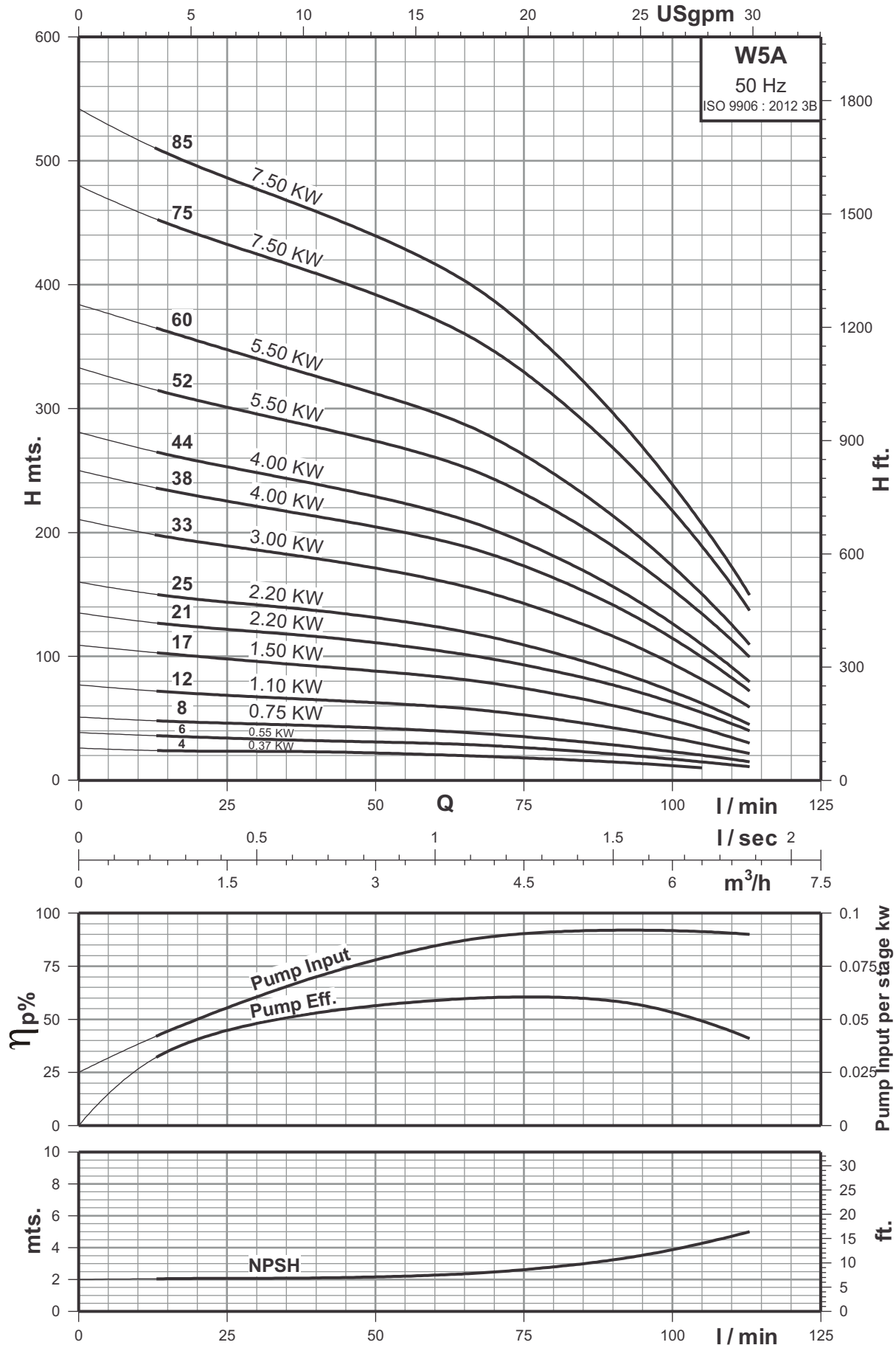

# Technical data

## Mixed flow 4" stainless steel submersible bore well pumps

# W8A

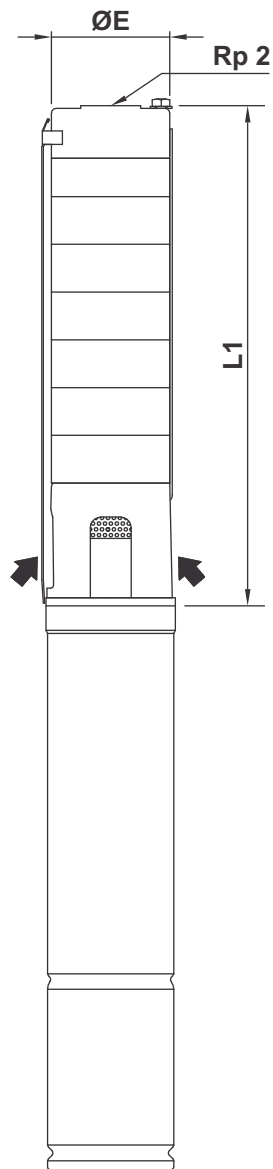

### Performance chart

Pump type	Motor type		kW	HP	Q m <sup>3</sup> /h l/min	n = 2900 rpm					
	Oil filled	Water filled				0	3	4.9	6.4	7.9	11.4
						0	50	83	108	133	190
W8A/5	H4510	L4510	0.75	1.00	H mts.	30	27	25	23	20	11
W8A/7	H4515	L4515	1.10	1.50		41	38	35	32	29	15
W8A/10	H4520	L4520	1.50	2.00		60	54	49	45	40	22
W8A/12	H4530	L4530	2.20	3.00		73	65	60	56	50	29
W8A/15	H4530	L4530	2.20	3.00		90	80	73	68	61	33
W8A/18	H4540	L4540	3.00	4.00		108	96	87	81	73	40
W8A/21	H4555	L4555	4.00	5.50		127	113	104	97	88	49
W8A/25	H4555	L4555	4.00	5.50		150	134	123	114	104	56
W8A/30	H4575	L4575	5.50	7.50		180	160	146	136	121	64
W8A/37	H4575	L4575	5.50	7.50		221	195	178	165	147	75
W8A/44	H45100	L6510-KP	7.50	10.0		263	230	210	196	177	90
W8A/50	H45100	L6510-KP	7.50	10.0		298	260	236	220	198	100
W8A/58	-	L6512-KP	9.30	12.5		346	304	275	256	230	117
W8A/66	-	L6515-KP	11.0	15.0		394	345	315	294	265	133
W8A/73	-	L6515-KP	11.0	15.0		434	380	344	320	290	144

### Dimensions & weights of only Pump

Pump Type	Motor Joining Size	ØE [mm]	L1 [mm]	Pump Gross weight [kg]	Pump Gross volume [m <sup>3</sup> ]
W8A/5	4"	101	409	5.0	0.0051
W8A/7	4"	101	493	6.3	0.0106
W8A/10	4"	101	619	8.0	0.0106
W8A/12	4"	101	703	9.1	0.0106
W8A/15	4"	101	829	10.7	0.0106
W8A/18	4"	101	955	12.4	0.0106
W8A/21	4"	101	1081	14.2	0.0162
W8A/25	4"	101	1249	16.4	0.0162
W8A/30	4"	101	1459	19.2	0.0162
W8A/37	4"	101	1753	23.5	0.0204
W8A/44	4"	101	1815	27.7	0.0228
W8A/44	6"	142	2109	29.4	0.0503
W8A/50	4"	101	2303	31.1	0.0256
W8A/50	6"	142	2361	33.3	0.0564
W8A/58	6"	142	3013	38.5	0.0645
W8A/66	6"	142	3349	70.7	0.3049
W8A/73	6"	142	3643	112.8	0.3645

W8A/73 is mounted in sleeve for Rp 2 connection.

Note: ØE = For single cable motor maximum diameter of pump inclusive of cable guard.  
All dimensions in mm unless otherwise noted.

# Performance curves

Mixed flow 4" stainless steel submersible bore well pumps

**W8A**

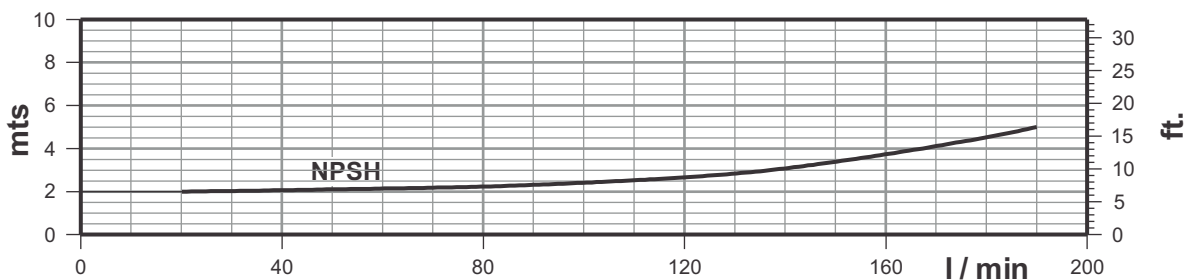
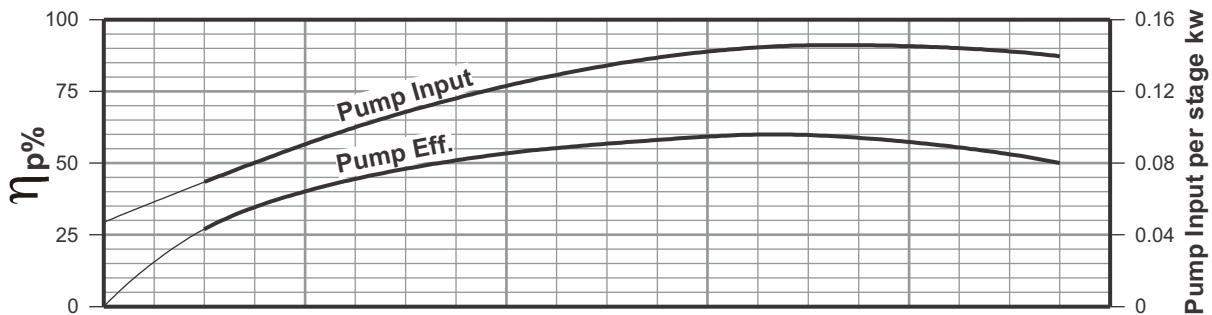
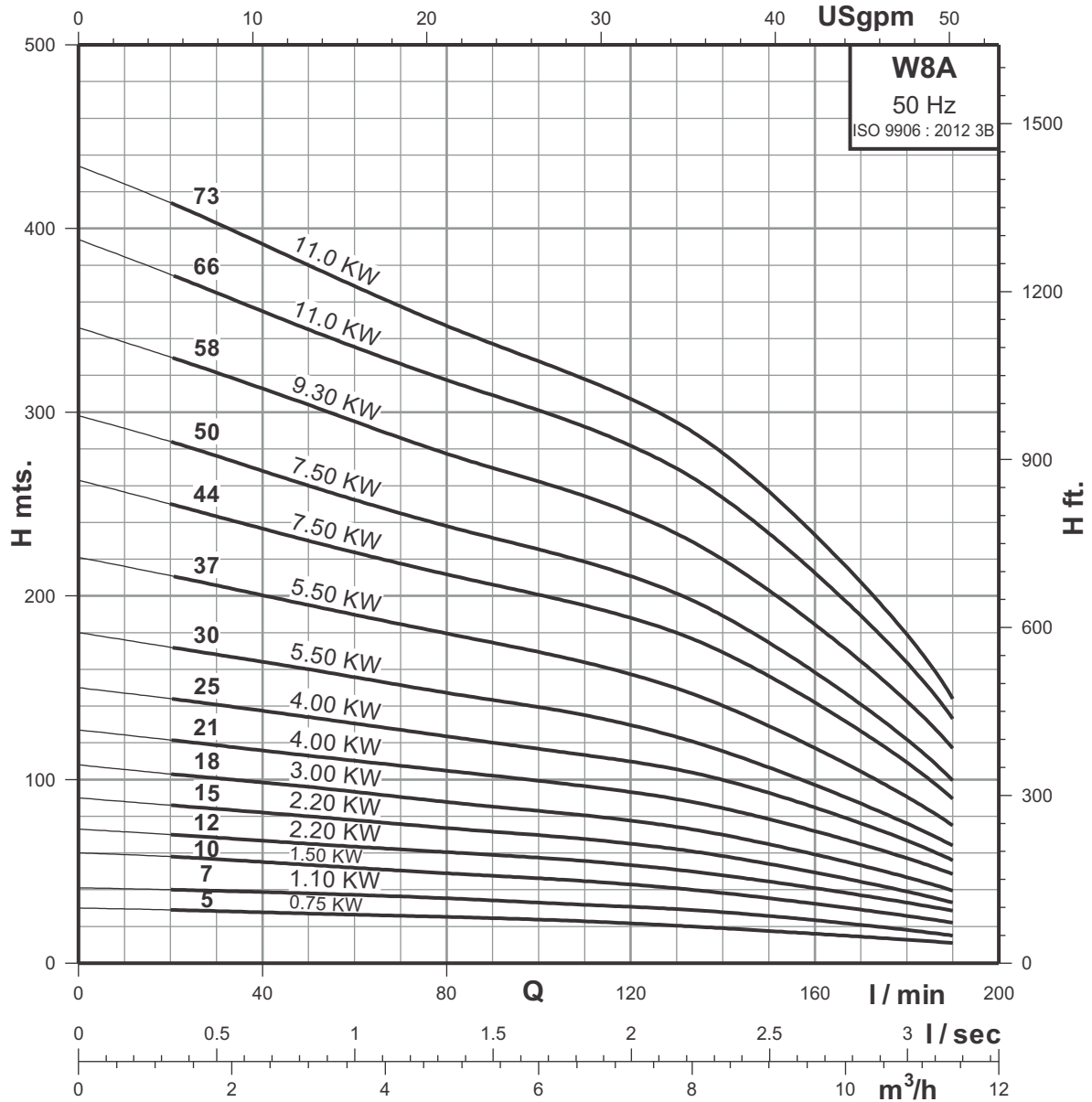

# Technical data

## Mixed flow 4" stainless steel submersible bore well pumps

## W14A

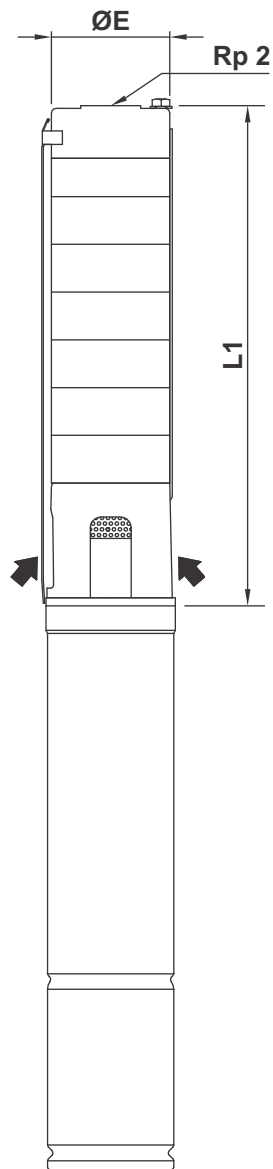

### Performance chart

Pump type	Motor type		kW	HP	Q m <sup>3</sup> /h l/min H mts.	n = 2900 rpm					
	Oil filled	Water filled				0	4	7.9	12	16	18.8
						0	68	133	200	267	313
W14A/5	H4520	L4520	1.50	2.00		33	33	30	26	19	12
W14A/7	H4530	L4530	2.20	3.00		46	46	42	37	27	18
W14A/10	H4540	L4540	3.00	4.00		66	66	60	52	38	24
W14A/13	H4555	L4555	4.00	5.50		86	86	78	67	50	32
W14A/18	H4575	L4575	5.50	7.50		119	118	108	94	69	44
W14A/25	H45100	L6510-KP	7.50	10.0		164	164	148	129	94	60

### Dimensions & weights of only Pump

Pump Type	Motor Joining Size	ØE [mm]	L1 [mm]	Pump Gross weight [kg]	Pump Gross volume [m <sup>3</sup> ]
W14A/5	4"	101	510	6.2	0.0106
W14A/7	4"	101	640	7.8	0.0106
W14A/10	4"	101	835	10.2	0.0106
W14A/13	4"	101	1030	12.8	0.0162
W14A/18	4"	101	1355	16.8	0.0162
W14A/25	4"	101	1810	22.9	0.0204
W14A/25	6"	142	1872	26.0	0.0540

**Note:** ØE = For single cable motor maximum diameter of pump inclusive of cable guard.  
All dimensions in mm unless otherwise noted.

# Performance curves

Mixed flow 4" stainless steel submersible bore well pumps

**W14A**

